

# CHILLED BEAM IQ STAR NOVA II

TECHNICAL CATALOGUE

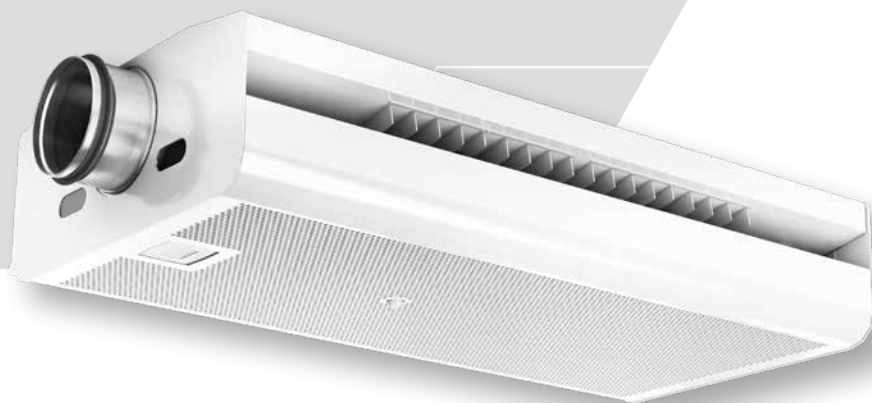

## IQ STAR NOVA II CHILLED BEAM



The NOVA II chilled beam is an active chilled beam system for ventilation, cooling and heating. This diffusion system offers comfort and flexibility thanks to the Flow Pattern Control combined with adjustable induction.

The Pi advanced function gives even more flexibility adding a Demand Controlled Ventilation function to the system. The air diffusion follows building occupancy and makes the HVAC system highly efficient.

NOVA II with Pi function is pressure independent and makes the system suitable for many duct work system types.

### QUICK SELECTION

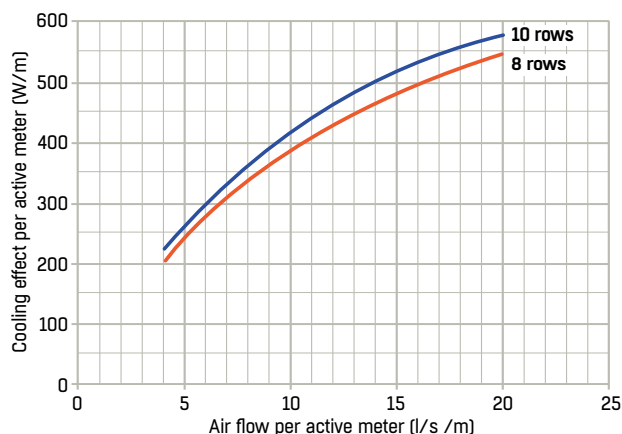

The diagram shows the total cooling effect per active metre at a total pressure of 70 Pa, water flow  $q_w = 0.05$  l/s, temperature difference between room air and supply air  $\Delta t = 8$  °C and temperature difference between mean water temperature and room temperature  $\Delta t = 8$  °C.

### KEY FEATURES

- Ventilation
- Water Heating and cooling
- Adjustable induction
- Flow Pattern Control
- In option: Demand Controlled Ventilation, Pressure independent, Lighting and Controls

### SPECIFICATIONS

- An active chilled beam for exposed installation
- Ensures comfort with low temperature gradient and no draught - FPC + EC
- Gives flexibility to the diffusion enabling lay out modification -FPC + EC
- Has in option a Demand Controlled Ventilation function, available as retrofit, independent from system pressure - Pi
- Available in two different executions: rectangular shape and rounded shape
- Includes fastening brackets for rapid and simple installation
- Openable front plate in one piece (Swing down)

### PRODUCT CODE EXAMPLE

Exposed chilled beam IQFI-180-11-07-1

## CONSTRUCTION AND FUNCTIONS

### CONSTRUCTION

This chilled beam is available in 120 cm, 150 cm, 180 cm, 210 cm, 240 cm, 270 cm, 300 cm and 330 cm standard lengths, is designed for exposed installation.

NOVA II is available in two different design; round and rectangular corners. The standard air connection on NOVA II is  $\varnothing_{Air}=125$  mm.

### MATERIAL AND SURFACE FINISH

The chilled beam casing is mainly made of galvanized steel sheet. The front plate is powder coated standard RAL 9003 white, 30% gloss which corresponds to NCS 0500-N. Heat exchanger coil made of aluminium fins mechanically bonded to copper pipes with  $\varnothing_{out} = 15$  mm end connections and 1.6 MPa maximum working pressure.

### FUNCTIONS

This chilled beam is designed for flexibility with a number of features optional to the basic standard model. Pi Function, Flow Pattern Control (FPC air deflector), Lighting, control and regulation equipment are the additional features available.

### ENERGY CONTROL (STANDARD)

Airflow for the chilled beam is easily adjustable with the patented Energy Control comprising variable nozzle settings mounted on rails that can be set for symmetrical or asymmetrical throw by adjustment of the nozzle in alignment with indicator on each side. 36 nozzle positions are available providing a wide choice of airflow settings for immediate and future requirements. Nozzle adjustment requires only a screwdriver to push the rails forward or backward to the desired position as shown below.

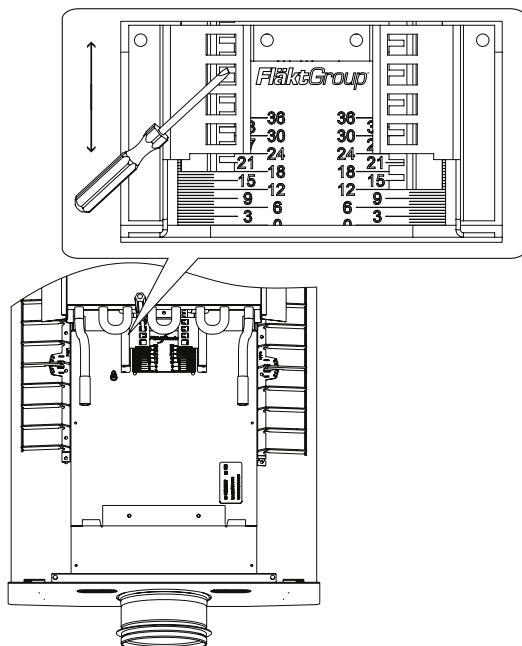

### PI FUNCTION (OPTION)

For Demand Controlled Ventilation operation, the Pi Function accessory must be mounted on the chilled beam. Thanks to this function, an actuator will then change automatically the nozzle position in order to change primary airflow.

The chilled beam system will be able to follow different operation sequences depending on the controller chosen. It is possible to set different airflows according to occupancy level or to manage air quality thanks to a CO<sub>2</sub> sensor connected to the controller. Three parameters can be set in the actuator : V<sub>0</sub> for non-occupancy, V<sub>min</sub> for standard occupancy and V<sub>max</sub> (boost) for high occupancy level.

Combined with the STRA-24 room controller, different modes are offered : OFF, Standby, unoccupied, occupied and boost. For each modes, different sequences between water and air are possible: cooling without free cooling, cooling with free cooling and airflow depending on CO<sub>2</sub>.

The Pi function keeps airflow at set point value despite pressure fluctuations in the duct. The Pi Function is easy to retrofit and applicable to any ductwork system owing to its pressure independent functionality.

Note when using Pi Function, induction is always symmetrical and a room controller is required to operate Pi Function with link to occupancy sensor. Duct pressure has to be maintained between 40 and 140 Pa.



Figure 1: Pi Function actuator

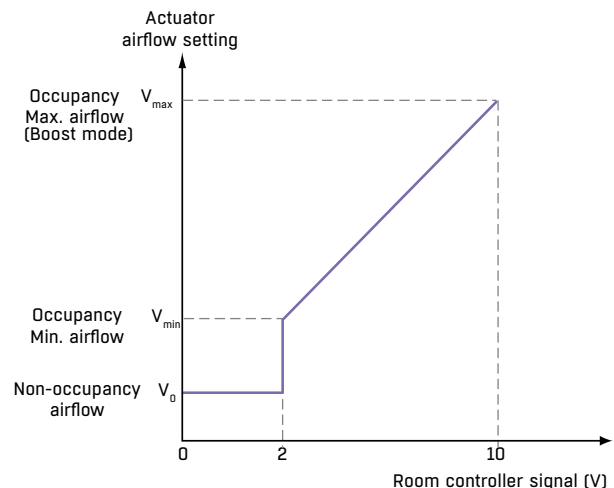

## CONSTRUCTION AND FUNCTIONS

### HEATING FUNCTION WITH PI

Naturally, warm air rises and remains at ceiling level when the heating function of a chilled beam is used and can therefore result in an unbalanced temperature gradient within the room. However, using a chilled beam with PI-function means that you can create stable ventilation whilst in heating mode. This is achieved by increasing the airflow when the demand for heating grows. When there is an demand for more heating the airflow is increased causing it collide with walls or other airstreams in the room and is then directed downwards to the occupied zone. The level of increased airflow in heating mode is an adjustable parameter in STRA-24 (parameter 49).

**CAUTION!** If Pi Function is installed as a retrofit, there is no need for a damper before the chilled beam. Any previously installed damper, should be set to fully open position or removed.

### FLOW PATTERN CONTROL (FPC)

The FPC (Flow Pattern Control) function provides high flexibility. The combination of Flow Pattern Control (FPC) and the patented Comfort Control gives unique characteristics to this chilled beam.

FläktGroup FPC air deflector enables easy adjustment of the air direction simply by repositioning the plastic blades as shown in illustration to the right.

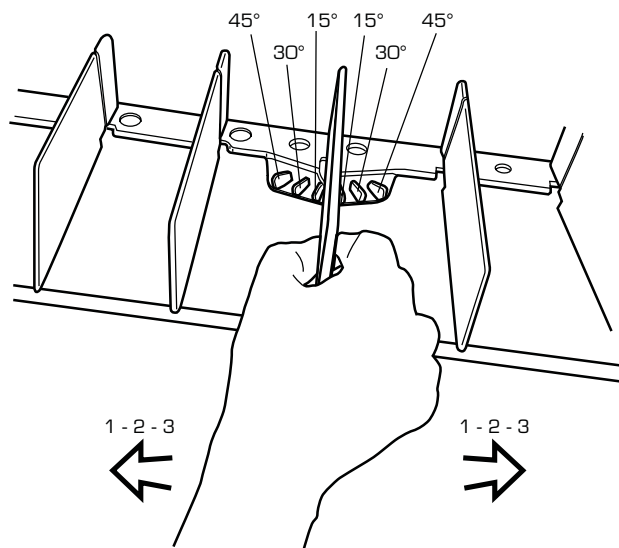

VAV control (Demand controlled ventilation) with PI actuator (IQAZ-35) is not available with change-over mode (heating or cooling with 2-pipe-system).

Illustration below shows FPC blades set at opposing 30° angle settings and with comfort control in symmetrical setting.

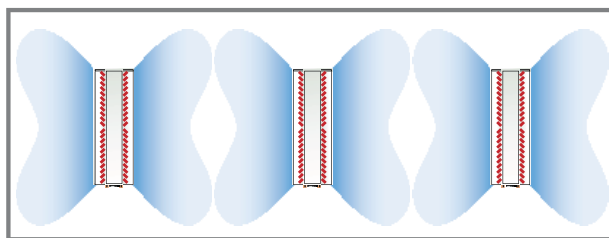

For high airflow applications as illustrated below, comfort control is in symmetrical setting, while FPC blades set at 30° angle settings on opposing units to avoid colliding air streams.

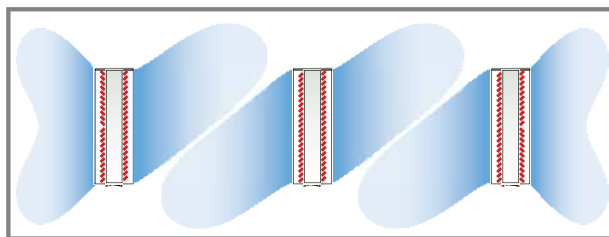

### INSTRUCTIONS

For installation, maintenance and commissioning instructions, please refer to specific manuals available on the Internet at [www.flaktgroup.com](http://www.flaktgroup.com).

## TECHNICAL DATA FOR COOLING EFFECT

### TWO-WAY CHILLED BEAM 10 ROWS (2-PIPE SYSTEM) AT PRESSURE DROP 70 PA ON THE AIR SIDE Ø125 MM

Beam length = 1.20 m (Coil length = 0.74 m)

Table 1: Water flow,  $q_w = 0.05$  l/s, Pressure drop,  $\Delta p_w = 3$  kPa

Nozzle opening mm	$q_{air}$ l/s	$P_{tot}$ in W for $\Delta t$ , °C			$P_{coil}$ in W for $\Delta t$ , °C			$L_{A10}$ dB(A)
		6	8	10	6	8	10	
6	4.0	173	217	262	134	179	224	<20
12	7.4	274	341	409	203	270	338	<20
18	10.6	348	430	512	246	328	410	<20
24	13.7	402	493	583	271	361	451	<20
30	16.9	444	538	632	282	376	470	20
36	20.0	480	576	672	288	384	480	23

Beam length = 1.50 m (Coil length = 1.04 m)

Table 2: Water flow,  $q_w = 0.05$  l/s, Pressure drop,  $\Delta p_w = 3.7$  kPa

Nozzle opening mm	$q_{air}$ l/s	$P_{tot}$ in W for $\Delta t$ , °C			$P_{coil}$ in W for $\Delta t$ , °C			$L_{A10}$ dB(A)
		6	8	10	6	8	10	
6	5.6	247	311	375	193	257	321	<20
12	10.1	382	477	572	285	380	475	<20
18	14.7	485	600	715	344	459	574	<20
24	19.3	563	689	815	378	504	630	<20
30	23.7	624	756	888	396	528	660	<20
36	28.1	673	808	942	404	538	673	22

Beam length = 1.80 m (Coil length = 1.34 m)

Table 3: Water flow,  $q_w = 0.05$  l/s, Pressure drop,  $\Delta p_w = 6$  kPa

Nozzle opening mm	$q_{air}$ l/s	$P_{tot}$ in W for $\Delta t$ , °C			$P_{coil}$ in W for $\Delta t$ , °C			$L_{A10}$ dB(A)
		6	8	10	6	8	10	
6	7.4	319	402	485	248	331	414	<20
12	13.2	497	621	744	371	494	618	<20
18	19.0	626	773	921	443	591	739	<20
24	24.7	724	886	1048	487	649	811	20
30	30.5	796	964	1132	503	671	839	25
36	35.9	856	1027	1197	512	682	853	32

Beam length = 2.10 m (Coil length = 1.64 m)

Table 4: Water flow,  $q_w = 0.05$  l/s, Pressure drop,  $\Delta p_w = 4.9$  kPa

Nozzle opening mm	$q_{air}$ l/s	$P_{tot}$ in W for $\Delta t$ , °C			$P_{coil}$ in W for $\Delta t$ , °C			$L_{A10}$ dB(A)
		6	8	10	6	8	10	
6	8.7	388	490	591	305	406	508	<20
12	15.7	598	748	897	448	597	746	<20
18	22.5	754	933	1112	538	717	896	<20
24	29.7	875	1072	1269	590	787	984	<20
30	36.5	964	1168	1373	614	818	1023	28
36	43.2	1035	1242	1448	620	827	1034	30

Beam length = 2.40 m (Coil length = 1.94 m)

Table 5: Water flow,  $q_w = 0.05$  l/s, Pressure drop,  $\Delta p_w = 5.5$  kPa

Nozzle opening mm	$q_{air}$ l/s	$P_{tot}$ in W for $\Delta t$ , °C			$P_{coil}$ in W for $\Delta t$ , °C			$L_{A10}$ dB(A)
		6	8	10	6	8	10	
6	10.5	451	568	685	350	467	584	<20
12	18.9	713	890	1068	532	709	886	<20
18	27.3	897	1108	1320	635	846	1058	<20
24	35.8	1034	1265	1495	691	921	1151	22
30	43.9	1135	1373	1611	714	952	1190	27
36	51.4	1214	1454	1695	721	961	1201	32

Beam length = 2.70 m (Coil length = 2.24 m)

Table 6: Water flow,  $q_w = 0.1$  l/s, Pressure drop,  $\Delta p_w = 6$  kPa

Nozzle opening mm	$q_{air}$ l/s	$P_{tot}$ in W for $\Delta t$ , °C			$P_{coil}$ in W for $\Delta t$ , °C			$L_{A10}$ dB(A)
		6	8	10	6	8	10	
6	11.6	525	662	800	413	551	689	<20
12	21.4	820	1025	1230	615	820	1025	<20
18	30.7	1021	1264	1506	727	969	1211	21
24	40.1	1181	1446	1711	796	1061	1326	22
30	49.2	1285	1555	1826	812	1083	1354	25
36	58.2	1372	1643	1914	813	1084	1355	28

Beam length = 3 m (Coil length = 2.54 m)

Table 7: Water flow,  $q_w = 0.05$  l/s, Pressure drop,  $\Delta p_w = 6.7$  kPa

Nozzle opening mm	$q_{air}$ l/s	$P_{tot}$ in W for $\Delta t$ , °C			$P_{coil}$ in W for $\Delta t$ , °C			$L_{A10}$ dB(A)
		6	8	10	6	8	10	
6	12.6	588	744	900	467	623	779	<20
12	23.1	912	1142	1372	690	920	1150	<20
18	33.8	1146	1420	1694	822	1096	1370	21
24	44.5	1313	1608	1903	886	1181	1476	24
30	54.6	1431	1733	2035	907	1209	1511	29
36	64.0	1522	1824	2127	908	1210	1513	31

Beam length = 3.30 m (Coil length = 2.84 m)

Table 8: Water flow,  $q_w = 0.05$  l/s, Pressure drop,  $\Delta p_w = 7.3$  kPa

Nozzle opening mm	$q_{air}$ l/s	$P_{tot}$ in W for $\Delta t$ , °C			$P_{coil}$ in W for $\Delta t$ , °C			$L_{A10}$ dB(A)
		6	8	10	6	8	10	
6	15.5	673	848	1023	524	699	874	<20
12	26.7	1017	1270	1524	761	1014	1268	<20
18	38.6	1284	1589	1893	914	1218	1523	22
24	50.0	1459	1785	2111	979	1305	1631	24
30	61.3	1572	1899	2227	983	1311	1639	28
36	71.2	1671	2001	2330	988	1317	1646	32

## TWO-WAY CHILLED BEAM 10 ROWS (2-PIPE SYSTEM) AT PRESSURE DROP 70 PA ON THE AIR SIDE Ø125 MM PARALLEL FLOW - 2 CIRCUITS

Beam length = 2.70 m (Coil length = 2.24 m)

Table 9: Water flow,  $q_w = 0.1$  l/s, Pressure drop,  $\Delta p_w = 4.5$  kPa

Nozzle opening mm	$q_{air}$ l/s	$P_{tot}$ in W for $\Delta t$ , °C			$P_{coil}$ in W for $\Delta t$ , °C			$L_{A10}$ dB(A)
		6	8	10	6	8	10	
6	11.6	503	633	764	392	522	653	<20
12	21.4	827	1034	1242	622	829	1036	<20
18	30.7	1048	1299	1550	753	1004	1255	21
24	40.1	1206	1480	1754	821	1095	1369	22
30	49.2	1314	1594	1875	842	1122	1403	25
36	58.2	1402	1683	1964	843	1124	1405	28

Beam length = 3 m (Coil length = 2.54 m)

Table 10: Water flow,  $q_w = 0.1$  l/s, Pressure drop,  $\Delta p_w = 5$  kPa

Nozzle opening mm	$q_{air}$ l/s	$P_{tot}$ in W for $\Delta t$ , °C			$P_{coil}$ in W for $\Delta t$ , °C			$L_{A10}$ dB(A)
		6	8	10	6	8	10	
6	12.6	574	725	876	453	604	755	<20
12	23.1	925	1159	1393	703	937	1171	<20
18	33.8	1184	1470	1757	860	1146	1433	21
24	44.5	1358	1668	1978	931	1241	1551	24
30	54.6	1471	1786	2102	947	1262	1578	29
36	64.0	1561	1876	2192	947	1262	1578	31

Beam length = 3.30 m (Coil length = 2.84 m)

Table 11: Water flow,  $q_w = 0.1$  l/s, Pressure drop,  $\Delta p_w = 5.5$  kPa

Nozzle opening mm	$q_{air}$ l/s	$P_{tot}$ in W for $\Delta t$ , °C			$P_{coil}$ in W for $\Delta t$ , °C			$L_{A10}$ dB(A)
		6	8	10	6	8	10	
6	15.5	657	826	995	508	677	846	<20
12	26.7	1032	1290	1549	776	1034	1293	<20
18	38.6	1319	1635	1951	948	1264	1580	22
24	50.0	1499	1839	2179	1019	1359	1699	24
30	61.3	1617	1960	2303	1029	1372	1715	28
36	71.2	1713	2056	2399	1029	1372	1715	32

**TWO-WAY CHILLED BEAM 8+2 ROWS (4-PIPE SYSTEM - COOLING/HEATING) AT PRESSURE DROP 70 PA ON THE AIR SIDE Ø125 MM**

**Beam length = 1.20 m (Coil length = 0.74 m)**

Table 20: Water flow,  $q_w = 0.05$  l/s, Pressure drop,  $\Delta p_w = 2.8$  kPa

Nozzle opening mm	$q_{air}$ l/s	$P_{tot}$ in W for $\Delta t, ^\circ C$			$P_{coil}$ in W for $\Delta t, ^\circ C$			$L_{A10}$ dB(A)
		6	8	10	6	8	10	
6	4.0	165	207	250	127	169	211	<20
12	7.4	260	323	386	189	252	315	<20
18	10.6	327	402	477	225	300	375	<20
24	13.7	378	460	542	246	328	410	<20
30	16.9	419	504	590	257	342	428	20
36	20.0	455	543	631	263	351	439	23

**Beam length = 1.50 m (Coil length = 1.04 m)**

Table 21: Water flow,  $q_w = 0.05$  l/s, Pressure drop,  $\Delta p_w = 3.4$  kPa

Nozzle opening mm	$q_{air}$ l/s	$P_{tot}$ in W for $\Delta t, ^\circ C$			$P_{coil}$ in W for $\Delta t, ^\circ C$			$L_{A10}$ dB(A)
		6	8	10	6	8	10	
6	5.6	235	296	356	182	242	303	<20
12	10.1	361	449	537	264	352	440	<20
18	14.7	458	563	669	317	422	428	<20
24	19.3	530	644	759	344	459	574	<20
30	23.7	585	704	823	357	476	595	<20
36	28.1	640	764	887	371	494	618	22

**Beam length= 1.80 m (Coil length = 1.34 m)**

Table 22: Water flow,  $q_w = 0.05$  l/s, Pressure drop,  $\Delta p_w = 4$  kPa

Nozzle opening mm	$q_{air}$ l/s	$P_{tot}$ in W for $\Delta t, ^\circ C$			$P_{coil}$ in W for $\Delta t, ^\circ C$			$L_{A10}$ dB(A)
		6	8	10	6	8	10	
6	7.4	302	379	456	231	308	385	<20
12	13.2	470	585	699	344	458	573	<20
18	19.0	590	726	862	408	544	680	<20
24	24.7	679	826	973	442	589	736	20
30	30.5	754	908	1062	461	615	769	25
36	35.9	816	974	1131	472	629	786	32

**Beam length= 2.10 m (Coil length = 1.64 m)**

Table 23: Water flow,  $q_w = 0.05$  l/s, Pressure drop,  $\Delta p_w = 4.5$  kPa

Nozzle opening mm	$q_{air}$ l/s	$P_{tot}$ in W for $\Delta t, ^\circ C$			$P_{coil}$ in W for $\Delta t, ^\circ C$			$L_{A10}$ dB(A)
		6	8	10	6	8	10	
6	8.7	368	463	557	284	379	474	<20
12	15.7	567	706	844	416	555	694	<20
18	22.5	713	879	1045	497	663	829	<20
24	29.7	822	1001	1180	537	716	895	<20
30	36.5	908	1094	1280	558	744	930	28
36	43.2	984	1174	1363	569	759	949	30

**Beam length = 2.40 m (Coil length = 1.94 m)**

Table 24: Water flow,  $q_w = 0.05$  l/s, Pressure drop,  $\Delta p_w = 5$  kPa

Nozzle opening mm	$q_{air}$ l/s	$P_{tot}$ in W for $\Delta t, ^\circ C$			$P_{coil}$ in W for $\Delta t, ^\circ C$			$L_{A10}$ dB(A)
		6	8	10	6	8	10	
6	10.5	438	551	663	338	450	563	<20
12	18.9	676	841	1006	495	660	825	<20
18	27.3	849	1045	1241	587	783	979	<20
24	35.8	974	1184	1394	630	840	1050	22
30	43.9	1073	1290	1508	652	869	1086	27
36	51.4	1156	1377	1598	663	884	1105	32

**Beam length = 2.70 m (Coil length = 2.24 m)**

Table 25: Water flow,  $q_w = 0.05$  l/s, Pressure drop,  $\Delta p_w = 5.5$  kPa

Nozzle opening mm	$q_{air}$ l/s	$P_{tot}$ in W for $\Delta t, ^\circ C$			$P_{coil}$ in W for $\Delta t, ^\circ C$			$L_{A10}$ dB(A)
		6	8	10	6	8	10	
6	11.6	505	636	768	394	525	656	<20
12	21.4	775	964	1154	569	759	949	<20
18	30.7	964	1187	1410	669	892	1115	21
24	40.1	1108	1349	1590	723	964	1205	22
30	49.2	1210	1456	1702	738	984	1230	25
36	58.2	1311	1562	1812	752	1003	1254	28

**Beam length = 3 m (Coil length = 2.54 m)**

Table 26: Water flow,  $q_w = 0.05$  l/s, Pressure drop,  $\Delta p_w = 6.1$  kPa

Nozzle opening mm	$q_{air}$ l/s	$P_{tot}$ in W for $\Delta t, ^\circ C$			$P_{coil}$ in W for $\Delta t, ^\circ C$			$L_{A10}$ dB(A)
		6	8	10	6	8	10	
6	12.6	558	704	850	437	583	729	<20
12	23.1	859	1072	1284	638	850	1063	<20
18	33.8	1082	1334	1587	758	1010	1263	21
24	44.5	1241	1512	1783	814	1085	1356	24
30	54.6	1350	1625	1900	826	1101	1376	29
36	64.0	1455	1735	2016	841	1121	1401	31

**Beam length = 3.3 m (Coil length = 2.84 m)**

Table 27: Water flow,  $q_w = 0.05$  l/s, Pressure drop,  $\Delta p_w = 6.7$  kPa

Nozzle opening mm	$q_{air}$ l/s	$P_{tot}$ in W for $\Delta t, ^\circ C$			$P_{coil}$ in W for $\Delta t, ^\circ C$			$L_{A10}$ dB(A)
		6	8	10	6	8	10	
6	15.5	640	804	968	491	655	819	<20
12	26.7	961	1195	1430	704	939	1174	<20
18	38.6	1214	1495	1776	843	1124	1405	22
24	50.0	1373	1670	1968	893	1190	1488	24
30	61.3	1497	1800	2103	909	1212	1515	28
36	71.2	1596	1901	2205	913	1217	1521	32

## TECHNICAL DATA FOR HEATING

### TWO-WAY CHILLED BEAM 8+2 ROWS (4-PIPE SYSTEM) COOLING/HEATING) AT PRESSURE DROP 70 PA ON THE AIR SIDE Ø125 MM.

**Beam length = 1.20 m (Coil length = 0.74 m)**

Table 28: Water flow,  $q_w = 0.05$  l/s, Pressure drop,  $\Delta p_w = 1.8$  kPa

Nozzle opening mm	$q_{air}$ l/s	$P_{coil\ heat}$ in W for $\Delta t, ^\circ C$			$L_{A10}$ dB(A)
		10	15	20	
6	4.0	109	163	217	<20
12	7.4	136	204	272	<20
18	10.6	152	228	304	<20
24	13.7	161	242	323	<20
30	16.9	165	248	331	20
36	20.0	235	352	469	23

**Beam length = 1.50 m (Coil length = 1.04 m)**

Table 29: Water flow,  $q_w = 0.05$  l/s, Pressure drop,  $\Delta p_w = 2$  kPa

Nozzle opening mm	$q_{air}$ l/s	$P_{coil\ heat}$ in W for $\Delta t, ^\circ C$			$L_{A10}$ dB(A)
		10	15	20	
6	5.6	155	232	309	<20
12	10.1	191	287	383	<20
18	14.7	215	322	429	<20
24	19.3	227	340	453	<20
30	23.7	231	346	461	<20
36	28.1	231	347	463	22

**Beam length = 1.80 m (Coil length = 1.34 m)**

Table 30: Water flow,  $q_w = 0.05$  l/s, Pressure drop,  $\Delta p_w = 2.2$  kPa

Nozzle opening mm	$q_{air}$ l/s	$P_{coil\ heat}$ in W for $\Delta t, ^\circ C$			$L_{A10}$ dB(A)
		10	15	20	
6	7.4	198	297	396	<20
12	13.2	247	370	493	<20
18	19.0	276	414	552	<20
24	24.7	290	435	580	20
30	30.5	297	445	593	25
36	35.9	297	445	593	32

**Beam length = 2.10 m (Coil length = 1.64 m)**

Table 31: Water flow,  $q_w = 0.05$  l/s, Pressure drop,  $\Delta p_w = 2.5$  kPa

Nozzle opening mm	$q_{air}$ l/s	$P_{coil\ heat}$ in W for $\Delta t, ^\circ C$			$L_{A10}$ dB(A)
		10	15	20	
6	8.7	243	364	485	<20
12	15.7	302	453	604	<20
18	22.5	337	505	673	<20
24	29.7	335	533	711	<20
30	36.5	360	540	720	28
36	43.2	361	541	721	30

**Beam length = 2.40 m (Coil length = 1.94 m)**

Table 32: Water flow,  $q_w = 0.05$  l/s, Pressure drop,  $\Delta p_w = 2.6$  kPa

Nozzle opening mm	$q_{air}$ l/s	$P_{coil\ heat}$ in W for $\Delta t, ^\circ C$			$L_{A10}$ dB(A)
		10	15	20	
6	10.5	287	430	573	<20
12	18.9	357	536	715	<20
18	27.3	396	594	792	<20
24	35.8	415	623	831	22
30	43.9	419	628	837	27
36	51.4	419	629	839	32

**Beam length = 2.70 m (Coil length = 2.24 m)**

Table 33: Water flow,  $q_w = 0.05$  l/s, Pressure drop,  $\Delta p_w = 2.8$  kPa

Nozzle opening mm	$q_{air}$ l/s	$P_{coil\ heat}$ in W for $\Delta t, ^\circ C$			$L_{A10}$ dB(A)
		10	15	20	
6	11.6	332	498	664	<20
12	21.4	412	618	824	<20
18	30.7	455	683	911	21
24	40.1	477	716	955	22
30	49.2	479	719	959	25
36	58.2	481	722	963	28

**Beam length = 3 m (Coil length = 2.54 m)**

Table 34: Water flow,  $q_w = 0.05$  l/s, Pressure drop,  $\Delta p_w = 3.1$  kPa

Nozzle opening mm	$q_{air}$ l/s	$P_{coil\ heat}$ in W for $\Delta t, ^\circ C$			$L_{A10}$ dB(A)
		10	15	20	
6	12.6	373	560	747	<20
12	23.1	465	697	929	<20
18	33.8	514	711	1028	21
24	44.5	535	803	1071	24
30	54.6	537	806	1075	29
36	64.0	539	809	1079	31

**Beam length = 3.3 m (Coil length = 2.84 m)**

Table 35: Water flow,  $q_w = 0.05$  l/s, Pressure drop,  $\Delta p_w = 3.5$  kPa

Nozzle opening mm	$q_{air}$ l/s	$P_{coil\ heat}$ in W for $\Delta t, ^\circ C$			$L_{A10}$ dB(A)
		10	15	20	
6	15.5	419	629	839	<20
12	26.7	514	771	1028	<20
18	38.6	576	864	1152	22
24	50.0	595	893	1191	24
30	61.3	596	894	1192	28
36	71.2	596	894	1192	32



## TECHNICAL AND SOUND DATA

### CONDITIONS FOR COOLING PERFORMANCE TABLES

Total cooling effect of beam,  $P_{tot}$  = cooling effect of coil,  $P_{coil}$  + cooling effect of supply air,  $P_{air}$ .

- Air side total pressure drop of 70 Pa.
- Water flow rate of 0.05 l/s per circuit.
- $\Delta t = 8^\circ \text{C}$  between room temperature and mean water temperature.
- $\Delta t = 8^\circ \text{C}$  between room temperature and supply air temperature.

Performance for water flows other than 0.05 l/s can be found in the Fläkt Group product selection tool, SELECT (select.flaktgroup.com).

The tables here are based on tests done according to the EN 15116 standard. The purpose of this standard is to be able to compare performances of different chilled beams on the same terms. The external heat supply method has been used where heating has been supplied evenly over the floors and walls such that the on-coil temperature is the same as the temperature at 1.1 m above floor level (seated head height).

In actual conditions, the temperature difference is normally  $1^\circ \text{C}$ . This is why the temperature  $\Delta t$  should be increased by  $1^\circ \text{C}$  to avoid over dimensioning of the beam.

This means that the table value concerned can be increased by 10 %. As such it is not uncommon for selections in SELECT to have  $1^\circ \text{C}$  increase between ceiling temperature and room temperature.

### DEFINITIONS

$q_l$	Supply airflow, l/s
$P_{tot}$	Total cooling effect, W
$P_{coil}$	Cooling effect of the coil, W
$P_{coil \text{ heat}}$	Heating effect of the coil, W
$\Delta t$	Difference between room air temperature and average water temperature, $^\circ \text{C}$

### TECHNICAL DATA FOR UNEQUAL AIR DIFFUSION

A chilled beam with two-way air distribution utilizes the coil in full capacity, which is not the case in one-way distribution or middle positions.

Table 36: Cooling capacity (W) for the coil with 10 rows at  $\Delta t = 8^\circ \text{C}$ , Total pressure 70 Pa and water flow 0.05 l/s.

Beam length, cm	120		150		180		210		240		270		300		330	
	Nozzle setting, mm	l/s	10 rows	l/s	10 rows	l/s	10 rows	l/s	10 rows	l/s	10 rows	l/s	10 rows	l/s	10 rows	
36-06	12.1	282	17.1	398	22.2	507	26.9	617	32.6	714	37.4	818	41.8	917	48.4	1008
36-12	13.8	409	19.4	574	25.1	735	30.4	890	36.9	1044	42.4	1190	47.1	1331	54.2	1457
30-06	10.5	278	14.8	393	19.3	501	23.2	612	28.2	710	31.8	817	35.6	916	41.4	1005
30-12	12.2	323	17.1	454	22.2	583	26.7	708	32.5	831	36.8	952	41.0	1065	47.2	1163
24-06	8.9	270	12.5	381	16.2	490	19.5	597	23.7	694	26.6	806	29.6	902	34.3	1002
24-12	10.6	394	14.8	553	19.1	714	23.0	865	27.9	1019	31.6	1176	35.0	1313	40.1	1449
18-06	7.3	254	10.2	358	13.3	461	15.7	562	19.1	657	21.5	760	23.7	860	27.7	959
18-12	9.0	299	12.4	420	16.2	543	19.3	657	23.4	778	26.5	895	29.0	1008	33.5	1116

$\Delta p_w$	Pressure drop water,, kPa
$\Delta t_w$	$(^\circ \text{C}) = P_{coil} \text{ (W)} / 208$
$\Delta t_w$	(US imperial) - $\Delta t_w \text{ (}^\circ \text{F)} = P_{coil} \text{ (BTU/tim)} / 81177$
$L_{A10}$	Sound pressure level in a room with 10 m <sup>2</sup> room absorption, dB(A)

### SOUND POWER LEVEL

NOVA II	Correction K dB [Octave band, middle frequency, Hz							
	63	125	250	500	1000	2000	4000	8000
120	4	3	4	3	0	-8	-17	-18
150	4	3	4	3	0	-8	-17	-18
180	4	3	4	3	0	-8	-17	-18
210	4	3	4	3	0	-8	-17	-18
240	4	3	4	3	0	-8	-17	-18
270	4	3	4	3	0	-8	-17	-18
300	4	3	4	3	0	-8	-17	-18
330	4	3	4	3	0	-8	-17	-18
Tol ±	4	2	2	1	1	2	3	8

The sound power levels for every octave band are obtained by adding together the sound pressure level  $L_{A10}$ , dB(A), and the corrections  $K_{oct}$  given in the table above, according to the following formula:

$$L_w = L_{A10} + K_{oct}$$

Correction  $K_{oct}$  is the average in the area of application of the chilled beam.

### SOUND ATTENUATION

The average sound attenuation  $\Delta L$  of the chilled beam from duct to room includes the end reflection of the connecting duct.

Sound attenuation in supply air duct of the beam $\Delta L$ , dB							
Octave band, middle frequency, Hz							
63	125	250	500	1000	2000	4000	8000
26	17	16	20	19	19	24	20

**DIMENSIONS AND WEIGHT**

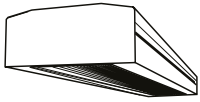

bb = 11, 12, 13, 14

**IQFI-aaa-11-09, 10-d**

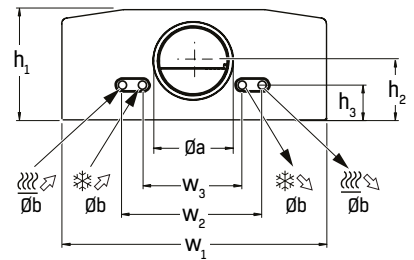
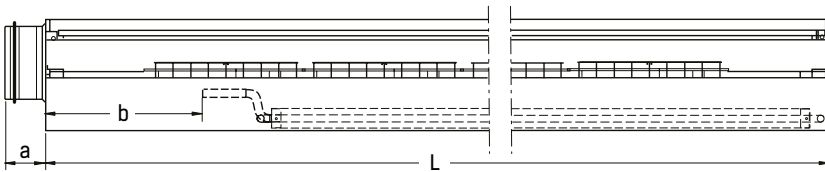

**IQFI-aaa-12-07, 08, 13, 14-d**

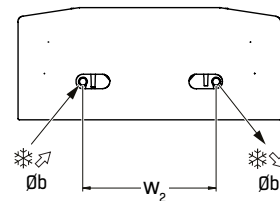
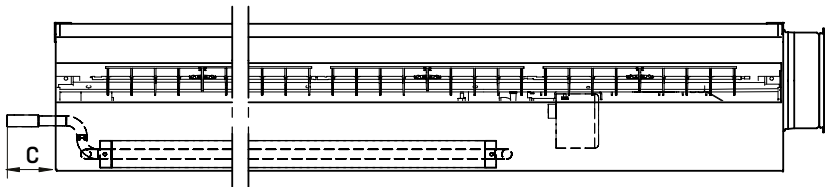

Øa	Øb	a	b	C	w1	w2	w3	h1	h2	h3
125	15	69	273	61	450	228	158	192	118	65

The air connection has a male connection for bb = 11/12.

- = Cooling water in
- = Cooling water out
- = Heating water in
- = Heating water out

**IQFI-aaa-13-cc-d**

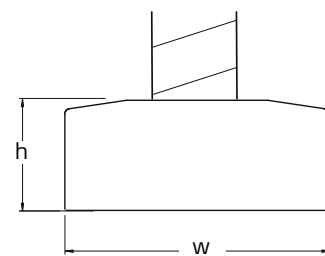
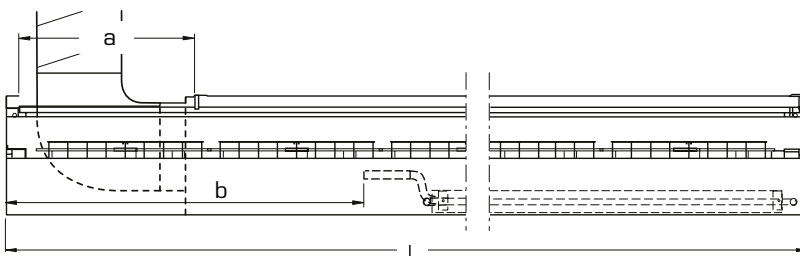

**IQFI-aaa-14-07, 08, 13, 14-d**

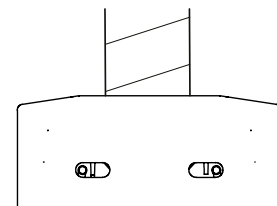
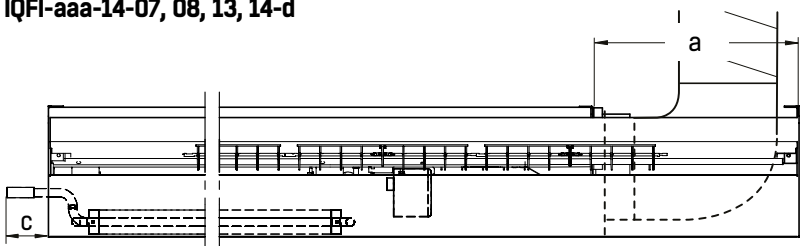

Øa	Øb	a	b	C	w	h
125	15	280	573	61	450	192

The air connection has a female connection for bb = 13/14.

All water connections have a male connection.

All dimensions in mm.

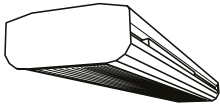

bb = 21, 22, 23, 24

**IQFI-aaa-21-09, 10-d**

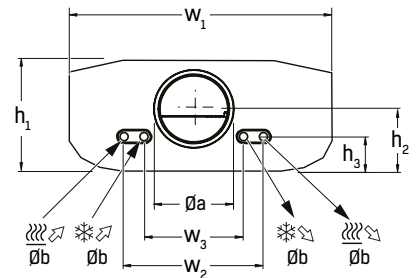
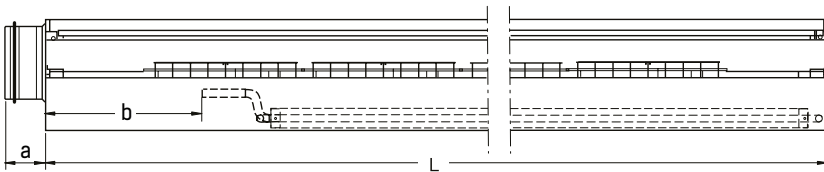

**IQFI-aaa-22-07, 08, 13, 14-d**

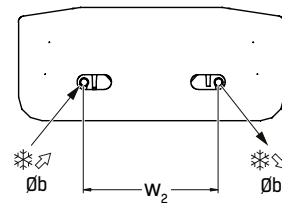
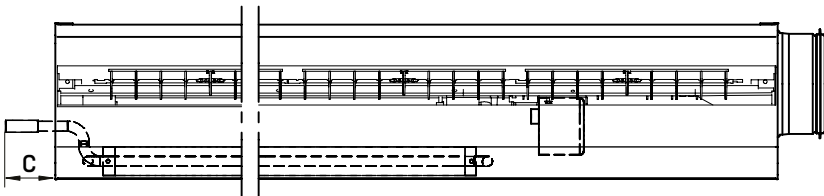

Øa	Øb	a	b	c	w1	w2	w3	h1	h2	h3
125	15	69	273	61	450	228	158	192	118	65

The air connection has a male connection for bb = 21/22.

- = Cooling water in
- = Cooling water out
- = Heating water in
- = Heating water out

**IQFI-aaa-23-cc-d**

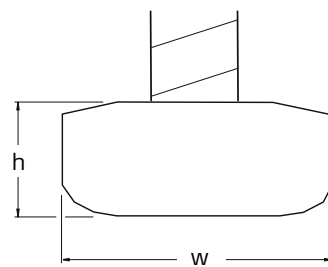
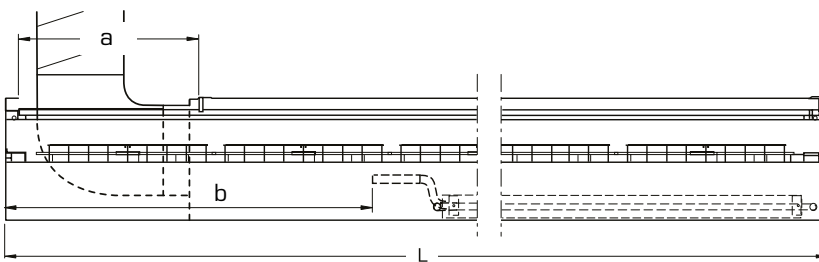

**IQFI-aaa-24-07, 08, 13, 14-d**

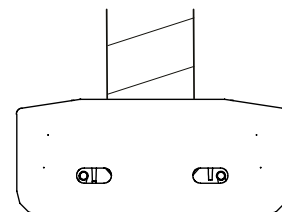
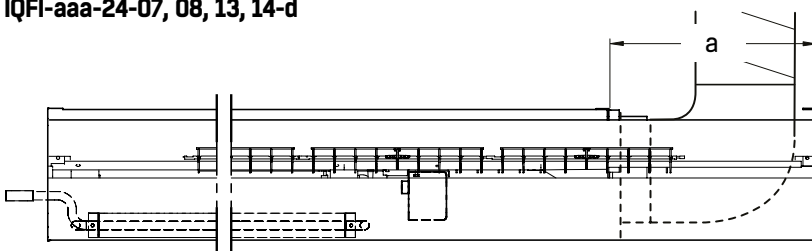

Øa	Øb	a	b	w	h
125	15	280	573	450	192

The air connection has a female connection for bb = 23/24.

All water connections have a male connection.

All dimensions in mm.

**LENGTH IQFI-aaa-11/12/21/22**

Length, aaa	120	150	180	210	240	270	300	330
L, mm	1200	1500	1800	2100	2400	2700	3000	3300

**LENGTH IQFI-aaa-13/14/23/24**

Length, aaa	120	150	180	210	240	270	300
L, mm	1500	1800	2100	2400	2700	3000	3300

**WATER CONTENT**

Water volume Cooling/Heating	Coil rows	Water content per length coil l/m
Cooling	10 rows	1,13
Cooling	8 rows	0,91
Heating	2 rows	0,23

**WATER CONNECTION TYPE IQFI-aaa-bb-cc-d**

CC position	Type
07, 08, 09, 10, 11, 12, 13, 14	Plain tail Ø15mm
15, 17, 19	G½" external thread, cylindrical

All water connections are male.

**WEIGHT**

Length, aaa in cm	120	150	180	210	240	270	300	330
Beam dry weight, kg	20	24	28	32	36	40	44	48
Beam water filled, kg	21	25	29	33	37	41	46	50

## ACCESSORIES

### FASTENING BRACKET QFAZ-18

A suspension bracket facilitates the suspension of chilled beams from the ceiling. Two brackets are used for each beam. The brackets can be ordered in advance or along with the chilled beam. The suspension brackets can be fitted directly to the ceiling or onto channel support bars. The chilled beam is simply attached by pressing it against the bracket until it clicks into place. No tools are needed. After this, the chilled beam can be adjusted lengthwise by sliding the bracket along the beam's fastening points. To adjust it sideways, slide the threaded bars along the grooves in the bracket.

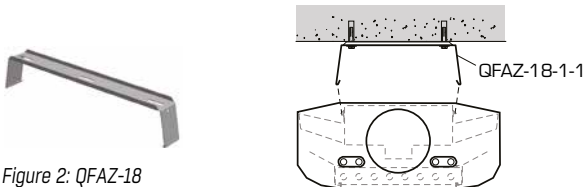

Figure 2: QFAZ-18

If there is a need for adjusting the installation height, suspension brackets and suspension rods M8 (QFAZ-12) can be ordered as well.

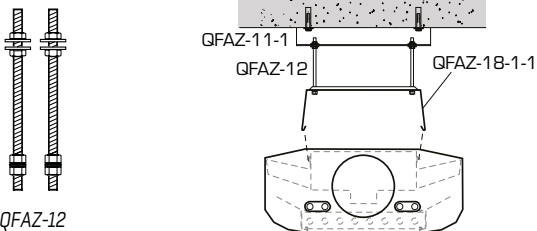

Figure 3: QFAZ-12

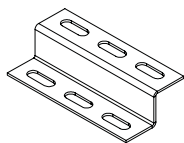
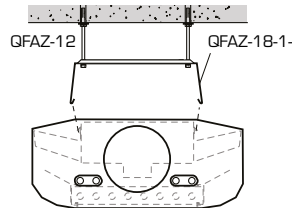

Figure 4: Suspension bracket QFAZ-11



### INSTALLATION WITH FASTENING BRACKET QFAZ-19

Low-build fastening bracket (QFAZ-19) is available for installation where there is a limited height to install the chilled beam.

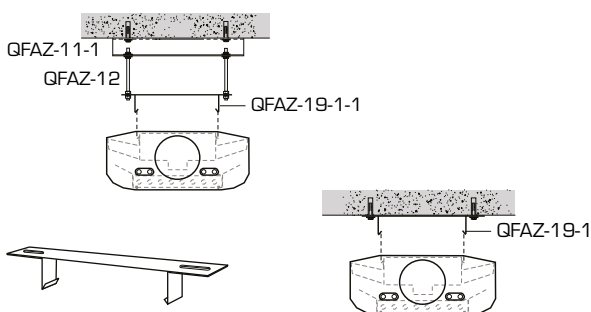

Figure 5: QFAZ-19-1-1

For more information regarding the installation procedures, please see the installation manual for this chilled beam.

### DUCT ENCLOSURE

Duct enclosure (IQAZ-30) is available in three size ranges for concealing water pipes and air ducts:

- 30 to 50 cm
- 50 to 90 cm
- 90 to 170 cm

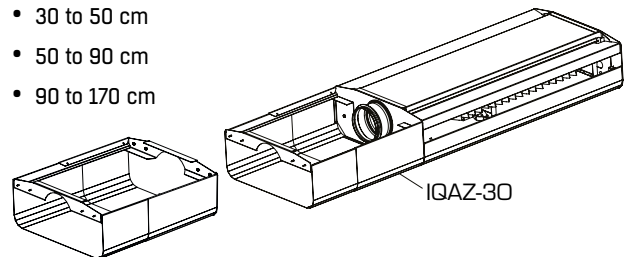

Figure 6: IQAZ-30

### PURGING NIPPLE

Purging nipple can be ordered separately or be selected in product code.

### FLEXIBLE HOSES

Flexible hoses are available with push-on connection for easy installation.

Push-on connection is suitable for pipe made of various plastics (PE, PA, PUR) as well as brass, copper and mild steel. For a stainless steel pipe, a groove must be made around the end of the pipe (360°) so that the stainless steel teeth of the connector can grip the pipe (groove length = 14.3 mm ±0.5 mm; groove depth = 0.05-0.08 mm with 90° opening angle).

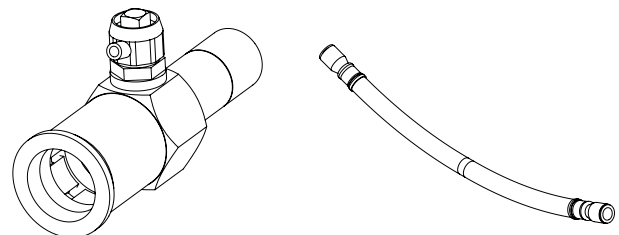

Purging nipple

IQAZ-19 flexible hose with push-on connection.

Push-on connection on purging nipple and flexible hose are John Guest type that are suitable for the following pressure and temperature ranges:

- 10 bar up to +23°C
- 7 bar up to +65°C

### NOZZLE ACTUATOR FOR PI FUNCTION

This chilled beam can be ordered with pressure independent air-flow control function which requires installation of IQAZ-35 nozzle actuator. The actuator comes with Modbus communication and can be supplied loose for post installation.

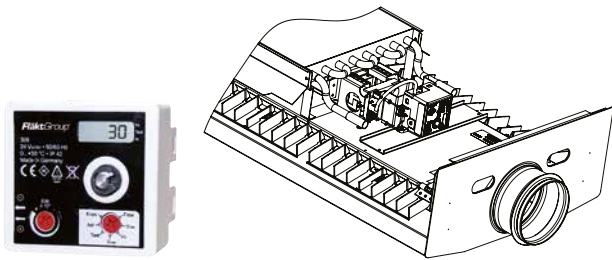

Figure 7: IQAZ-35

For more information regarding the installation procedures, please see the installation manual for this chilled beam.

### ROOM CONTROLLER STRA-24

STRA-24 is a pre-programmed room controller intended to control the temperature and the CO<sub>2</sub> level in rooms. It manages the water coil actuator and the actuator of the Pi function. It is pre-programmed with communication and is intended for use in premises with high comfort and low energy demands.

The STRA-24 is able to optimise energy consumption in rooms depending on different parameters: occupancy, CO<sub>2</sub> level, outside conditions (free cooling feature) and timetable.

Different modes are offered : OFF, Standby, occupied and boost.

For each modes, different sequences between water and air are possible : cooling without free cooling, cooling with free cooling and airflow depending on CO<sub>2</sub>.

For more information regarding this product and related accessories, please see the STRA-24 technical catalogue.



Figure 12: STRA-24 Room Controller

### VALVES AND ACTUATORS

To see full description and technical data for valve kit, please see the STRA Accessories catalogue.



Figure 13: STRZ-70

Valves with push-on connection are suitable for following pressure and temperature ranges:

- 16 bar up to +30°C
- 10 bar up to +65°C

### INTEGRATED CONTROL

NOVA II is available with integrated control by ordering the accessory STRZ-76. The room controller can be positioned in three different locations depending on the desired level of accessibility.

Actuators and valves are fixed on NOVA II in factory. A very simple operation allows the installer to connect it with no risk of leakage. The valves, optional condensate sensor and optional PIR (presence detector) are factory wired to a terminal block which is mounted behind the front plate of the unit. The PIR is mounted and integrated in the front plate. If the Pi-actuator (IQAZ-35) is chosen it will also be wired to the terminal block.

The integrated control offers Modbus or Bacnet communication as standard and it allows you to connect directly to the IPSUM system without using the IPSUM Connection unit.

From the room controller, it is possible to make the commissioning, increase and decrease temperature and display main information. For more information regarding this product and related accessories, please see the **STRA-24 technical catalogue and STRA Accessories catalogue**.

**SLAVE**

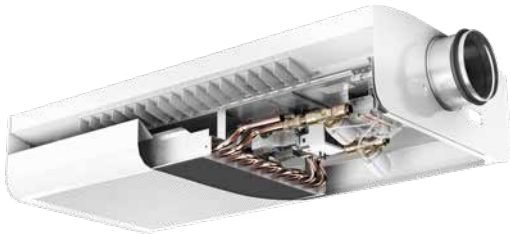

For parallel control. On site the installer needs to connect the room controller from the master beam to the terminal block placed on top of the NOVA II.

<b>Code:</b>	STRZ-76-00-cc-1-ee
<b>Connection Socket:</b>	YES
<b>Cooling/Heating:</b>	Cooling, Cooling & Heating <sup>1)</sup>
<b>External temperature sensor included:</b>	NO

<sup>1)</sup> If the chilled beam have cooling & heating, the actuators and valves are placed on the outside of the beam.

**MOUNTED ON TOP OF THE FRONT PLATE**



The room controller is factory mounted and wired on top of the front plate of NOVA II hidden from sight. In this configuration, the temperature sensor built into the room control tower is used. Temperature and condensation (in option) sensor are factory wired.

<b>Code:</b>	STRZ-76-02-cc-1-ee
<b>Connection Socket:</b>	YES
<b>Cooling/Heating:</b>	Cooling <sup>1)</sup>
<b>External temperature sensor included:</b>	NO

<sup>1)</sup> The heat of the chilled beam required external temperature sensor on the wall ordered separately.

**CONTROLLER SUPPLIED LOOSE**

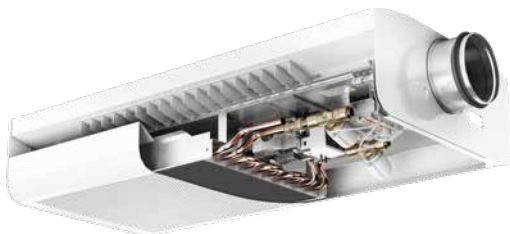

The room controller is supplied loose. On site the installer needs to connect the room controller to the terminal block placed behind the front plate of the NOVA II. This configuration uses the integrated temperature sensor in the room controller.

Condensation sensor (in option) is factory wired.

<b>Code:</b>	STRZ-76-01-cc-1-ee
<b>Connection Socket:</b>	YES
<b>Cooling/Heating:</b>	Cooling, Cooling & Heating <sup>1)</sup>
<b>External temperature sensor included:</b>	NO

<sup>1)</sup> If the chilled beam have cooling & heating, the actuators and valves are placed on the outside of the beam.

**CONTROLLER INTEGRATED IN FRONT PLATE**

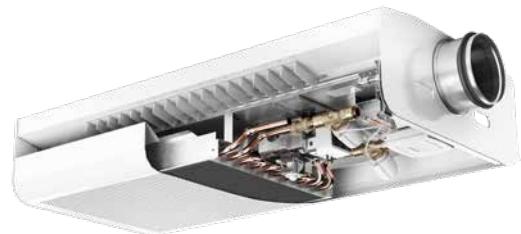

The room controller is integrated in the front plate of NOVA II and wired. This configuration uses the temperature sensor built into the room controller. Condensation sensor (in option) is factory wired.

<b>Code:</b>	STRZ-76-03-cc-1-ee
<b>Connection Socket:</b>	YES
<b>Cooling/Heating:</b>	Cooling <sup>1)</sup>
<b>External temperature sensor included:</b>	NO

<sup>1)</sup> The heat of the chilled beam required external temperature sensor on the wall ordered separately.

## LIGHTING



In certain cases, there is a requirement to provide the chilled beam with lighting function. Ceiling space is made available in this way, and a number of functions are combined in the same chilled beam. The installation costs can be reduced in this way, because fewer products need to be installed.

Nova can be equipped with direct lighting. With direct lighting there is a requirement both for a given intensity of illumination, for

example on a work surface, and for the air from the beam to ventilate the occupied zone effectively without creating draught problems. It is necessary in this case to find the right positioning of the beam to be able to guarantee the right intensity of illumination and good ventilation comfort.

The lighting function is offered to the rectangular shaped version of NOVA (bb = 11, 12, 13, 14).

### PRODUCT FACTS

- LED is used as a light source
- The connection cable can be supplied with a plug, loose ends, Wieland
- DALI ballast can be selected, then the connection cable with loose ends
- There are 2 different executions for LED:
  - -Notor Recessed LED Opal flush
  - -Notor Recessed LED Opal dropped





**NOTOR RECESSED LED OPAL FLUSH**

With length 1200: Light output (Lamp) 1798 lm, Light output (Light source) 1798 lm

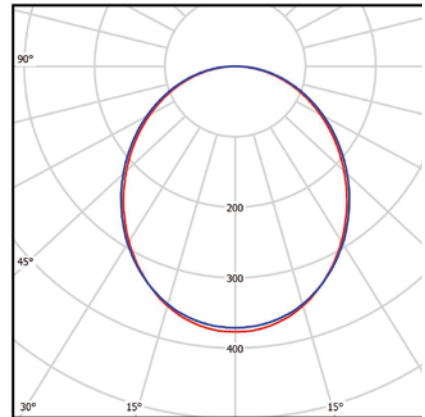
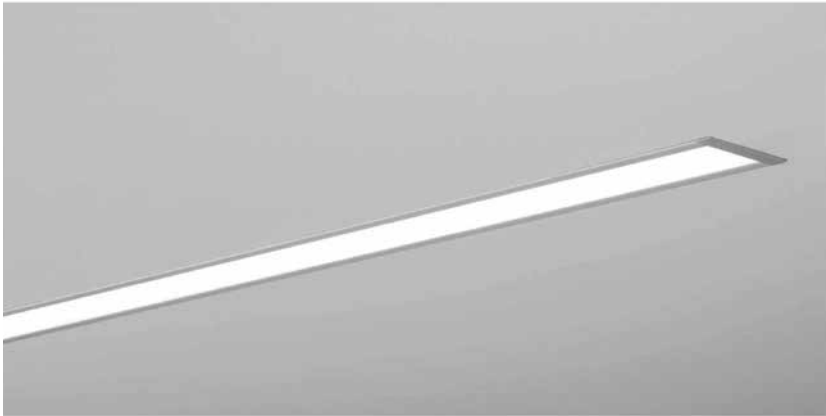

**NOTOR RECESSED LED OPAL DROPPED**

With length 1200: Light output (Lamp) 1855 lm, Light output (Light source) 1855 lm

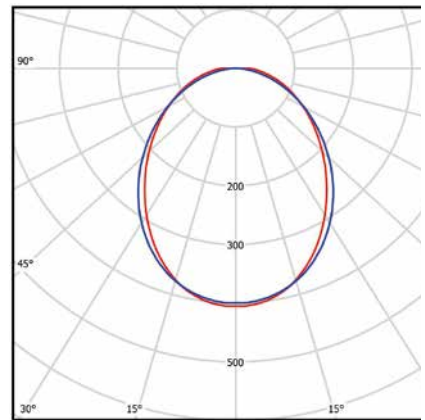
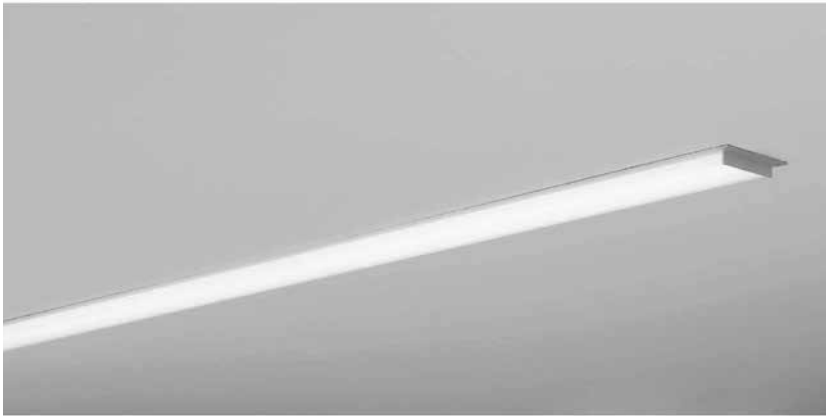

**IQFI WITH LIGHTING IQAZ-31**

**IQIF-aaa-11-cc-d with lighting**

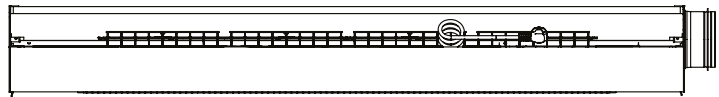
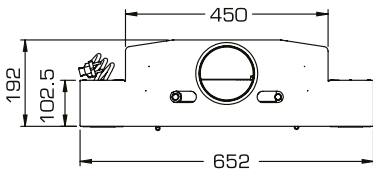

**IQIF-aaa-12-cc-d with lighting**

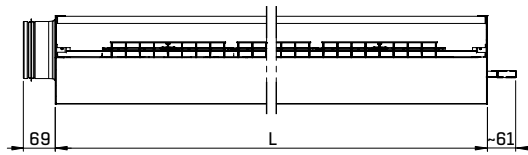
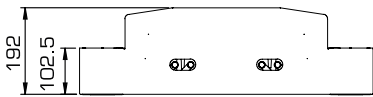

**DIMENSIONS LIGHTING**

Beam lengths - aaa (cm)	120	150	180	210	240	270	300	330
L = Length of light fittings, LED	589	1174	1174	1174	1174	1174	1174	1174
Number of light fittings	2	2	2	2	2	2	4	4

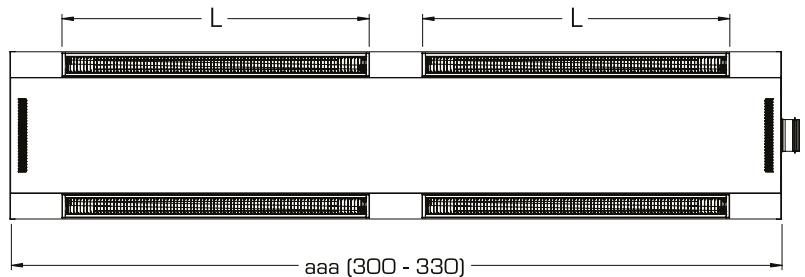
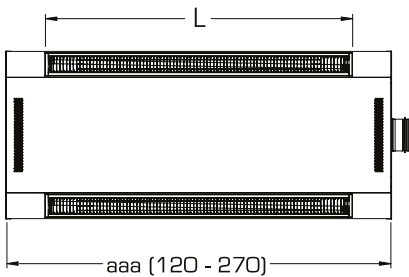

## PRODUCT AND ACCESSORIES CODES

### PRODUCT CODE

#### NOVA II chilled beam

IQFI-aaa-bb-cc-d

Length (aaa) (cm) \_\_\_\_\_  
 120, 150, 180, 210, 240, 270, 300, 330

#### Construction (bb)

- 11 = Normal flow, rectangular shape, air/water same gable, Ø125
- 12 = Normal flow, rectangular shape, air/water opposite gables, Ø125
- 13 = Normal flow, rectangular shape, air/water same gable, extended 300 mm, Ø125 (only aaa=090-300)
- 14 = Normal flow, rectangular shape, air/water opposite gables, extended 300 mm, Ø125 (only aaa=090-300)
- 21 = Normal flow, round shape, air/water same gable, Ø125
- 22 = Normal flow, round shape, air/water opposite gables, Ø125
- 23 = Normal flow, round shape, air/water same gable, extended 300 mm, Ø125 (only aaa=090-300)
- 24 = Normal flow, round shape, air/water opposite gables, extended 300 mm, Ø125 (only aaa=090-300)

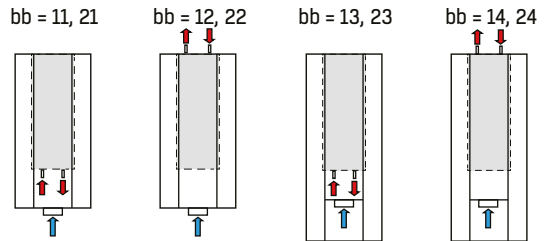

#### Coil construction (cc)

- 07 = Cooling 10 tubes
- 08 = Cooling 10 tubes with purging nipple
- 09 = Cooling\Heating - 8\2 tubes
- 10 = Cooling\Heating - 8\2 tubes with purging nipple
- 11 = Parallel flow cooling 10 tubes (only aaa=270, 300, 330)
- 12 = Parallel flow cooling 10 tubes with purging nipple (only aaa=270, 300, 330)
- 13 = Parallel flow cooling 10 tubes (only aaa=270, 300, 330)
- 14 = Parallel flow cooling 10 tubes with purging nipple (only aaa=270, 300, 330)
- 15 = Cooling 10 tubes, G½" external thread, cylindrical
- 17 = Cooling\Heating - 8\2 tubes, G½" external thread, cylindrical
- 19 = Parallel flow cooling 10 tubes, G½" external thread, cylindrical (only aaa=270, 300, 330)

#### Comfort Control (d)

- 1 = Without FPC
- 2 = With FPC

**ACCESSORY CODES****Pi Function actuator****IQAZ-35-02-c-1-e**

## Cable execution (c)

- 1 = Cable 1m without contact  
 2 = Cable 80mm with RJ45-contact (female) for use with IPSUM Connection unit and is not compatible in combination with STRZ-76<sup>1)</sup>

## Installation (e)

- 1 = Installed on chilled beam  
 2 = Supplied loose

<sup>1)</sup> Please note that RJ45-contact has an extended delivery time

bb = 11, 21      bb = 12, 22      bb = 13, 23      bb = 14, 24

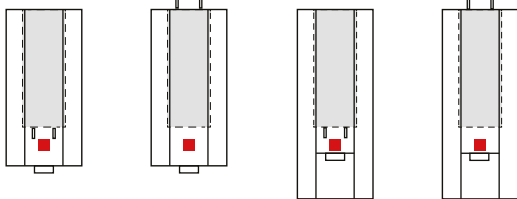

■ = IQAZ-35

**Pre-set Pi actuator****IQAZ-36-bbb-cccccc**

## k100% (bbb)

- 247 = IQFI-120  
 355 = IQFI-150  
 455 = IQFI-180  
 550 = IQFI-210  
 670 = IQFI-240  
 765 = IQFI-270  
 850 = IQFI-300  
 955 = IQFI-330

Airflow  $V_0$ ,  $V_{min}$ ,  $V_{max}$  l/s (cccccc)<sup>2)</sup>

- cc---- =  $V_0$   
 --cc-- =  $V_{min}$   
 ----cc =  $V_{max}$

<sup>2)</sup> Ordering example below

Eg: IQAZ-36-355-020420

- k100% = 3.54
- $V_0$  = 2 l/s
- $V_{min}$  = 4 l/s
- $V_{max}$  = 20 l/s

**Actuator and valve Siemens****STRZ-70-bb-cc-0-1**

## Valve (bb)

- 00 = Without  
 01 = DN15 (kvs 0.25-1.9) female 1/2" valve inlet  
 02 = DN20 (kvs 0.25-2.6) female 3/4" valve inlet  
 03 = DN25 (kvs 0.25-2.6) female 1" valve inlet  
 11 = DN15 (kvs 0.25-1.9) Compression ring valve inlet  
 21 = DN15 (kvs 0.25-1.9) Push on valve inlet  
 41 = DN15 Pressure independent (100-575 l/h) female 1/2" valve inlet  
 42 = DN20 Pressure independent (220-1330 l/h) female 3/4" valve inlet  
 43 = DN25 Pressure independent (280-1800 l/h) female 1" valve inlet  
 51 = DN15 Pressure independent (100-575 l/h) Compression ring valve inlet  
 61 = DN15 Pressure independent (100-575 l/h) Push on valve inlet

## Valve actuator(cc)

- 00 = Without  
 01 = 24 V NC cable 1 m  
 11 = 24 V NO cable 1 m  
 21 = 230 V NC cable 1 m  
 31 = 230 V NO cable 1 m

**Integrated controls****STRZ-76-bb-cc-1-05**

Only for IQFI, product code bb = 11 and 21

## Placement of controller (bb)

- 00 = Without room controller (slave)  
 01 = Supplied loose  
 02 = Mounted behind front plate  
 03 = Integrated in front plate

## Sensors and valve kit (valve and actuator) (cc)

- 00=without sensor, valve and actuators cooling  
 01 = Cooling valvekit  
 02 = Cooling valvekit, condensate sensor  
 03 = Cooling valvekit, PIR  
 04 = Cooling valvekit, condensate sensor, PIR

**Options only for bb = 00 and 01**

- 05 = Cooling and heating valvekit  
 06 = Cooling and heating valvekit, condensate sensor  
 07 = Cooling and heating valvekit, PIR  
 08 = Cooling and heating valvekit, condensate sensor, PIR  
 09 = without sensor, valve and actuators cooling/heating

Valves included in the STRZ-76 kit are of DN15 type with compression fitting. Included valve actuators are of 24V NC type.

**Fastening brackets** **QFAZ-18-1-2**

Set with 2 pieces, 1 set per beam

2 = Painted RAL 9003 gloss 30% (NCS 0500-N)

**Fastening brackets (low-build)** **QFAZ-19-1-1**

Set with 2 pieces, unpainted, 1 set per beam

**Suspension rods M8** **QFAZ-12**

Set with 2 pieces. Length 500 mm, 2 sets per beam

**Suspension bracket** **QFAZ-11-1**

Set with 2 pieces, unpainted, 1 set per beam

**Flexible hose (Push-on Ø15mm)** **IQAZ-19-550-010010**

Length = 550 mm

**Duct enclosure** **IQAZ-30-bbb-c**

Length (bbb)

050 = 30 - 50 cm

090 = 50 - 90 cm

170 = 90 - 170 cm

Design (cc)

1 = Rectangular shape

2 = Rounded shape

**Lighting** **IQAZ-31-bbb-cc-d-1**

Length (bbb) (cm)

(aaa in chilled beam code when bb = 11, 12)

(aaa + 30 in chilled beam code when bb = 13, 14)

Execution (cc)

05 = Downlight Opal flush, LED

06 = Downlight Opal dropped, LED

Connection cable (d)

0 = without

1 = Length 2 m loose wire connection

2 = Length 2 m plug connection

3 = Length 2 m male Wieland

4 = Length 2 m male 5-pin connector for DALI

<sup>3)</sup> **aaa** and **bb** refer to beam length and construction, respectively. Please see Product code section.

**Compression fitting** **IQAZ-38-b-c**

Connection 1 (b)

1 = 15 mm compression ring

Connection 2 (c)

1 = G½" external thread, cylindrical (ISO 228-1)

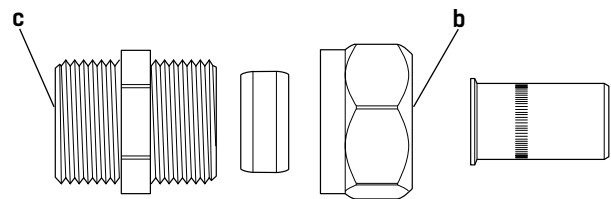

## ORDER EXAMPLE

### ORDER EXAMPLE

Here is an example to demonstrate an order complete with typical accessories. For more information about orders or specific requirements for special units, please contact your nearest FläktGroup sales office.

An order example for a room with 5 chilled beams. The beams are calculated as 270 cm length for required airflow and cooling capacity in product selection tool SELECT (<http://select.flaktgroup.com>).

### CHILLED BEAMS

Product codes	Description	Quantity
IQFI-270-11-10-2	NOVA II chilled beam, water cooling and heating with purging nipple,with FPC, for exposed installation	5
QFAZ-18-6-1	Fastning bracket, set of 2 for installation	5

### OPTION FOR DEMAND CONTROLLED VENTILATION

Product codes	Description	Quantity
IQAZ-35-02-1-1-1	Pi Function, Nozzle actuator, 1 piece per chilled beam	5

### CONTROLS

Product codes <sup>1)</sup>	Description	Quantity
STRA-24-00-0-00	Room Controller	1
STRZ-05-02	External temperature sensor	1
STRZ-16-1	Condensation sensor	1
STRZ-24-1	Transformer <sup>1)</sup>	1

### CONTROLS OPTIONS FOR DEMAND CONTROLLED VENTILATION

Product codes <sup>1)</sup>	Description	Quantity
STRZ-09-2	Occupancy detector (for single office application)	1
STRZ-18-1-2	CO <sub>2</sub> sensor (for meeting room)	1

### VALVES, ACTUATORS AND FLEXIBLE HOSES

Product codes <sup>1)</sup>	Description	Quantity
STRZ-70-11-01-0-1 <sup>1)</sup>	Valve + valve actuator	10
IQAZ-19-550-010010	Flexible hose push-on	10

### DUCT ENCLOSURE AND LIGHTING

Product codes	Description	Quantity
IQAZ-30-170-1	Rectangular duct enclosure, length 90 - 170 cm	5
IQAZ-31-270-06-1	Integrated lighting (LED), 2 fittings per beam, Length 1174 mm, with 2 m loose wire	5

<sup>1)</sup> For more information, please see the STRA-24 technical manual and STRA Accessories catalogue.

### PTC.312 DUCTED SPACE COOLING APPLIANCES

The FläktGroup's NOVA II chilled beam for integrated installation in suspended ceilings, has the following requirements/functions: (the size, variant etc., are indicated in the product code).

- Eurovent certified.
- Cooling, ventilation or Cooling, water heating, ventilation or Cooling, electric heating, ventilation.
- Pi motorised continuously variable VAV function, including an unoccupied flow mode
  - or EC for the simple continuously variable adjustment of air flows, and the potential for installing a VAV (Pi) motor at a later stage.
- Heating function in which heating is delivered by the water coil, and circulation in the space is controlled by the VAV function (Pi).
- FPC (flow pattern control).
- Extended casing; see the order code, for easier access to the motor, actuator etc., (also recommended for installation in acoustic ceiling systems).
- "Click-in" mounting brackets for easier installation.
- RAL 9003 gloss value 30.
- Factory fitted controls. All electrical components are connected to terminal blocks for the straightforward connection of a 24 V power supply.
- Water actuator with valves with compression fittings.
- Controller integrated into the front panel.
  - or Controller mounted on the side above the suspended ceiling (concealed from the room).
  - or Supplied separately for fitting in an optional location.
- Variant according to the order code for NOVA II (IQFI).
- Accessories as specified.
- STRA-XX controls as specified.

## EXCELLENCE IN SOLUTIONS

FläktGroup is the European market leader for smart and energy efficient Indoor Air and Critical Air solutions to support every application area. We offer our customers innovative technologies, high quality and outstanding performance supported by more than a century of accumulated industry experience. The widest product range in the market, and strong market presence in 65 countries worldwide, guarantee that we are always by your side, ready to deliver Excellence in Solutions.

### PRODUCT FUNCTIONS BY FLÄKTGROUP

Air Treatment | Air Movement | Air Diffusion | Air Distribution | Air Filtration  
Air Management & ATD's | Air Conditioning & Heating | Controls | Service

» Learn more on [www.flaktgroup.com](http://www.flaktgroup.com)  
or contact one of our offices